

# LM4873 Boomer® Audio Power Amplifier Series

## Dual 2.1W Audio Amplifier Plus Stereo Headphone Function

### General Description

The LM4873 is a dual bridge-connected audio power amplifier which, when connected to a 5V supply, will deliver 2.1W to a 4Ω load (Note 1) or 2.4W to a 3Ω load (Note 2) with less than 1.0% THD+N. In addition, the headphone input pin allows the amplifiers to operate in single-ended mode when driving stereo headphones. A MUX control pin allows selection between the two stereo sets of amplifier inputs. The MUX control can also be used to select two different closed-loop responses.

Boomer audio power amplifiers were designed specifically to provide high quality output power from a surface mount package while requiring few external components. To simplify audio system design, the LM4873 combines dual bridge speaker amplifiers and stereo headphone amplifiers on one chip.

The LM4873 features an externally controlled, low-power consumption shutdown mode, a stereo headphone amplifier mode, and thermal shutdown protection. It also utilizes circuitry to reduce "clicks and pops" during device turn-on.

**Note 1:** An LM4873MTE-1, LM4873MTE, or LM4873LQ that has been properly mounted to a circuit board will deliver 2.1W into 4Ω. The other package options for the LM4873 will deliver 1.1W into 8Ω. See the Application Information sections for further information concerning the LM4873MTE-1, LM4873MTE, and the LM4873LQ.

**Note 2:** An LM4873MTE-1, LM4873MTE, or LM4873LQ that has been properly mounted to a circuit board and forced-air cooled will deliver 2.4W into 3Ω.

### Key Specifications

- P<sub>O</sub> at 1% THD+N
  - LM4873LQ, 3Ω, 4Ω loads 2.4W(typ), 2.1W(typ)
  - LM4873MTE-1, 3Ω, 4Ω loads 2.4W(typ), 2.1W(typ)
  - LM4873IBL, 8Ω load 1.1W(typ)
  - LM4873MTE, 4Ω 1.9W(typ)
  - LM4873, 8Ω 1.1W(typ)
- Single-ended mode THD+N at 75mW into 32Ω 0.5%(max)
- Shutdown current 0.7μA(typ)
- Supply voltage range 2V to 5.5V

### Features

- Input mux control and two separate inputs per channel
- Stereo headphone amplifier mode
- "Click and pop" suppression circuitry
- Thermal shutdown protection circuitry
- PCB area-saving micro SMD and thin micro SMD packages
- TSSOP and exposed-DAP TSSOP and LLP packages

### Applications

- Multimedia monitors
- Portable and desktop computers
- Portable audio systems

### Connection Diagrams

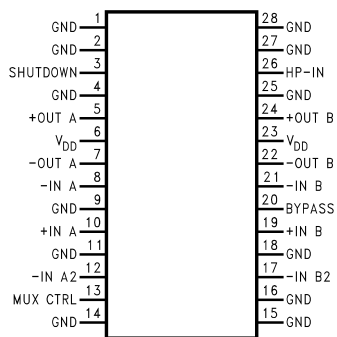

Top View

Order Number LM4873MTE-1  
See NS Package Number MXA28A for Exposed-DAP TSSOP

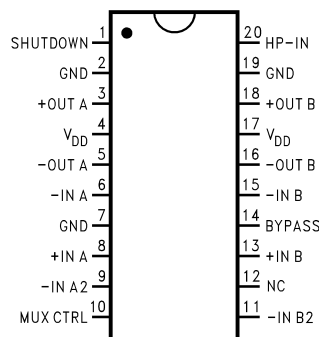

Top View

Order Number LM4873MT, LM4873MTE  
See NS Package Number MTC20 for TSSOP  
See NS Package Number MXA20A for Exposed-DAP TSSOP

Boomer® is a registered trademark of National Semiconductor Corporation.

Connection Diagrams (Continued)

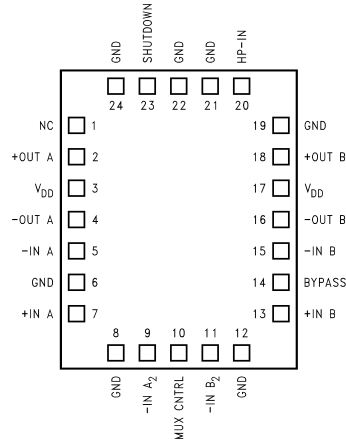

Top View

Order Number LM4873LQ

See NS Package Number LQA24A for Exposed-DAP LLP

micro SMD Marking

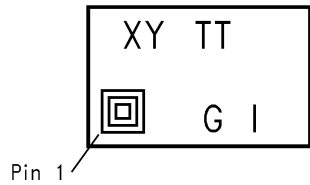

Top View

XY - Date Code  
 TT - Die Traceability  
 G - Boomer Family  
 I - LM4873IBL

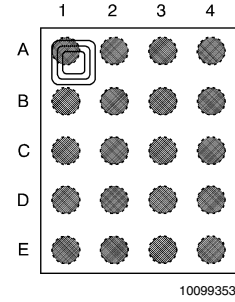

Top View

(Bump-side down)

Order Number LM4873IBL, LM4873ITL

See NS Package Number BLA20AAB for micro SMD

See NS Package Number TLA20AAA

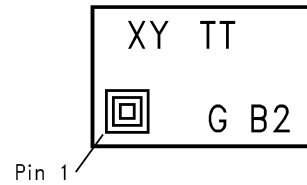

Top View

XY - Date Code  
 TT - Die Traceability  
 G - Boomer Family  
 B2 - LM4873ITL

LM4873IBP Pin Designations

Pin (Bump) Number	Pin (Bump) Function	Pin (Bump) Number	Pin (Bump) Function
A1	-IN A <sub>1</sub>	C3	V <sub>DD</sub>
A2	-IN A <sub>2</sub>	C4	+IN B
A3	-IN B <sub>2</sub>	D1	+OUT A
A4	-IN B <sub>1</sub>	D2	GND
B1	-OUT A	D3	GND
B2	GND	D4	+OUT B
B3	GND	E1	MUX CTRL
B4	-OUT B	E2	SHUTDOWN
C1	+IN A	E3	HP-IN
C2	V <sub>DD</sub>	E4	BYPASS

# Typical Application

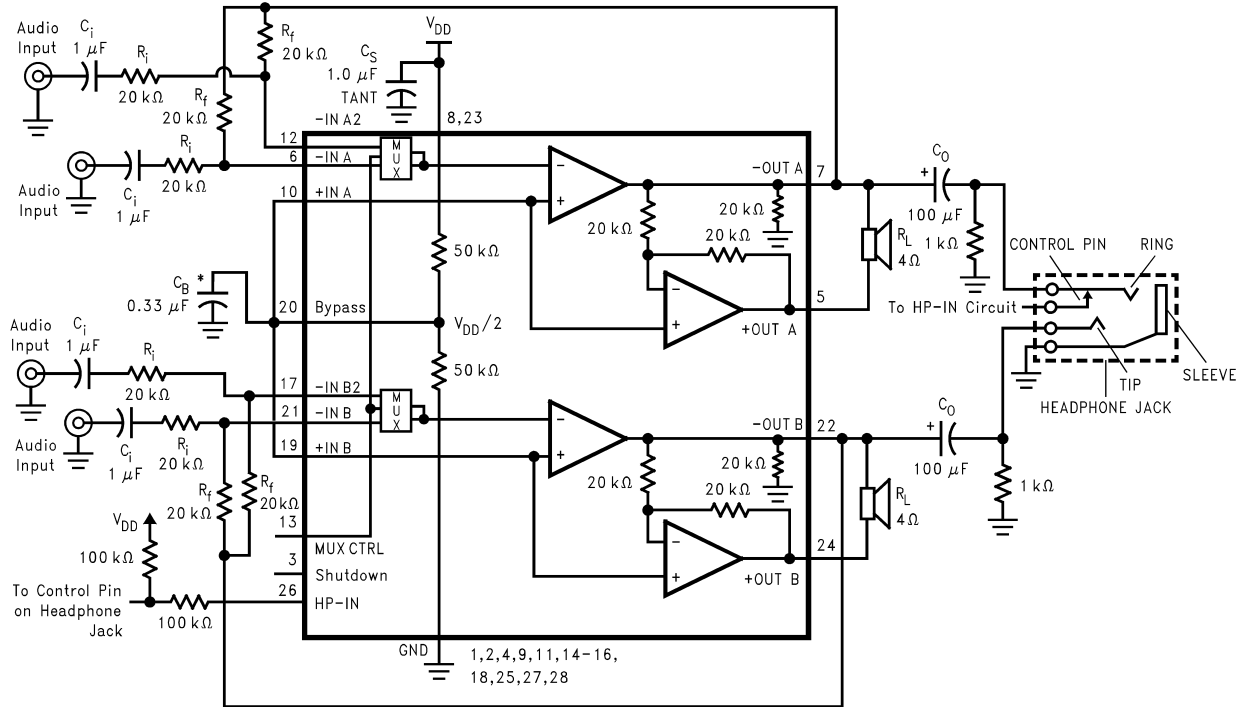

10099331

Note: Pin out shown for the 28-pin Exposed-DAP TSSOP package. Refer to the Connection Diagrams for the pin out of the 20-pin Exposed-DAP TSSOP, Exposed-DAP LLP, and micro SMD packages.

**Absolute Maximum Ratings** (Note 3)

If Military/Aerospace specified devices are required, please contact the National Semiconductor Sales Office/Distributors for availability and specifications.

Supply Voltage	6.0V
Storage Temperature	-65°C to +150°C
Input Voltage	-0.3V to $V_{DD}$ +0.3V
Power Dissipation (Note 4)	Internally limited
ESD Susceptibility (Note 5)	2000V
ESD Susceptibility (Note 6)	200V
Junction Temperature	150°C
Solder Information	
Small Outline Package	
Vapor Phase (60 sec.)	215°C
Infrared (15 sec.)	220°C
See AN-450 "Surface Mounting and their Effects on Product Reliability" for other methods of soldering surface mount devices.	
Thermal Resistance	

$\theta_{JC}$ (typ) — MTC20	20°C/W
$\theta_{JA}$ (typ) — MTC20	80°C/W
$\theta_{JC}$ (typ) — MXA20A	2°C/W
$\theta_{JA}$ (typ) — MXA20A	41°C/W (Note 7)
$\theta_{JA}$ (typ) — MXA20A	51°C/W (Note 8)
$\theta_{JA}$ (typ) — MXA20A	90°C/W (Note 9)
$\theta_{JC}$ (typ) — MXA28A	2°C/W
$\theta_{JA}$ (typ) — MXA28A	41°C/W (Note 10)
$\theta_{JA}$ (typ) — MXA28A	51°C/W (Note 11)
$\theta_{JA}$ (typ) — MXA28A	90°C/W (Note 12)
$\theta_{JC}$ (typ) — LQA24A	3.0°C/W
$\theta_{JA}$ (typ) — LQA24A	42°C/W (Note 13)
$\theta_{JA}$ (typ) — micro SMD	60°C/W (Note 14)

**Operating Ratings**

Temperature Range	$T_{MIN} \leq T_A \leq T_{MAX}$	$-40^\circ\text{C} \leq T_A \leq 85^\circ\text{C}$
Supply Voltage		$2.0\text{V} \leq V_{DD} \leq 5.5\text{V}$

**Electrical Characteristics** (Notes 3, 15)

The following specifications apply for  $V_{DD} = 5\text{V}$  unless otherwise noted. Limits apply for  $T_A = 25^\circ\text{C}$ .

Symbol	Parameter	Conditions	LM4873		Units (Limits)
			Typical (Note 16)	Limit (Note 17)	
$V_{DD}$	Supply Voltage			2	V (min)
				5.5	V (max)
$I_{DD}$	Quiescent Power Supply Current	$V_{IN} = 0\text{V}$ , $I_O = 0\text{A}$ (Note 18), HP-IN = 0V	7.5	15	mA (max)
		$V_{IN} = 0\text{V}$ , $I_O = 0\text{A}$ (Note 18), HP-IN = 4V	5.8	6	mA (min)
$I_{SD}$	Shutdown Current	$V_{DD}$ applied to the SHUTDOWN pin	0.7	2	$\mu\text{A}$ (max)
$V_{IH}$	Headphone High Input Voltage			4	V (min)
$V_{IL}$	Headphone Low Input Voltage			0.8	V (max)

**Electrical Characteristics for Bridged-Mode Operation** (Notes 3, 15)

The following specifications apply for  $V_{DD} = 5\text{V}$  unless otherwise specified. Limits apply for  $T_A = 25^\circ\text{C}$ .

Symbol	Parameter	Conditions	LM4873		Units (Limits)
			Typical (Note 16)	Limit (Note 17)	
$V_{OS}$	Output Offset Voltage	$V_{IN} = 0\text{V}$	5	50	mV (max)
$P_O$	Output Power (Note 19)	THD+N = 1%, f = 1kHz (Note 20)			
		LM4873MTE-1, $R_L = 3\Omega$	2.4		W
		LM4873MTE, $R_L = 3\Omega$	2.2		W
		LM4873LQ, $R_L = 3\Omega$	2.2		W
		LM4873MTE-1, $R_L = 4\Omega$	2.1		W
		LM4873MTE, $R_L = 4\Omega$	1.9		W
		LM4873LQ, $R_L = 4\Omega$	1.9		W
		LM4873MT, $R_L = 4\Omega$	1.9		W
		LM4873, $R_L = 8\Omega$	1.1	1.0	W (min)

## Electrical Characteristics for Bridged-Mode Operation (Notes 3, 15) (Continued)

The following specifications apply for  $V_{DD} = 5V$  unless otherwise specified. Limits apply for  $T_A = 25^\circ C$ .

Symbol	Parameter	Conditions	LM4873		Units (Limits)
			Typical (Note 16)	Limit (Note 17)	
		THD+N = 10%, f = 1kHz (Note 20) LM4873MTE-1, $R_L = 3\Omega$ LM4873LQ, $R_L = 3\Omega$ LM4873MTE-1, $R_L = 4\Omega$ LM4873LQ, $R_L = 4\Omega$ LM4873, $R_L = 8\Omega$ THD+N = 1%, f = 1kHz, $R_L = 32\Omega$	3.0 3.0 2.6 2.6 1.5 0.34		W W W W W W
THD+N	Total Harmonic Distortion+Noise	20Hz $\leq f \leq$ 20kHz, $A_{VD} = 2$ LM4873MTE-1, $R_L = 4\Omega$ , $P_O = 2W$ LM4873LQ, $R_L = 4\Omega$ , $P_O = 2W$ LM4873, $R_L = 8\Omega$ , $P_O = 1W$	0.3 0.3		 %
PSRR	Power Supply Rejection Ratio	$V_{DD} = 5V$ , $V_{RIPPLE} = 200mV_{RMS}$ , $R_L = 8\Omega$ , $C_B = 1.0\mu F$	67		dB
$X_{TALK}$	Channel Separation	f = 1kHz, $C_B = 1.0\mu F$	80		dB
SNR	Signal To Noise Ratio	$V_{DD} = 5V$ , $P_O = 1.1W$ , $R_L = 8\Omega$	97		dB

## Electrical Characteristics for Single-Ended Operation (Notes 3, 15)

The following specifications apply for  $V_{DD} = 5V$  unless otherwise specified. Limits apply for  $T_A = 25^\circ C$ .

Symbol	Parameter	Conditions	LM4873		Units (Limits)
			Typical (Note 16)	Limit (Note 17)	
$V_{OS}$	Output Offset Voltage	$V_{IN} = 0V$	5	50	mV (max)
$P_O$	Output Power	THD+N = 0.5%, f = 1 kHz, $R_L = 32\Omega$ THD+N = 1%, f = 1 kHz, $R_L = 8\Omega$ THD+N = 10%, f = 1 kHz, $R_L = 8\Omega$	85 340 440	75	mW (min) mW mW
THD+N	Total Harmonic Distortion+Noise	$A_V = -1$ , $P_O = 75mW$ , 20Hz $\leq f \leq$ 20kHz, $R_L = 32\Omega$	0.2		%
PSRR	Power Supply Rejection Ratio	$C_B = 1.0\mu F$ , $V_{RIPPLE} = 200mV_{RMS}$ , f = 1kHz	52		dB
$X_{TALK}$	Channel Separation	f = 1kHz, $C_B = 1.0\mu F$	60		dB
SNR	Signal To Noise Ratio	$V_{DD} = 5V$ , $P_O = 340mW$ , $R_L = 8\Omega$	94		dB

**Note 3:** Absolute Maximum Ratings indicate limits beyond which damage to the device may occur. Operating Ratings indicate conditions for which the device is functional, but do not guarantee specific performance limits. Electrical Characteristics state DC and AC electrical specifications under particular test conditions which guarantee specific performance limits. This assumes that the device operates within the Operating Ratings. Specifications are not guaranteed for parameters where no limit is given. The typical value however, is a good indication of device performance.

**Note 4:** The maximum power dissipation must be derated at elevated temperatures and is dictated by  $T_{JMAX}$ ,  $\theta_{JA}$ , and the ambient temperature  $T_A$ . The maximum allowable power dissipation is  $P_{DMAX} = (T_{JMAX} - T_A)/\theta_{JA}$ . For the LM4873,  $T_{JMAX} = 150^\circ C$ . For the  $\theta_{JA}$ s for different packages, please see the Application Information section or the Absolute Maximum Ratings section.

**Note 5:** Human body model, 100 pF discharged through a 1.5 k $\Omega$  resistor.

**Note 6:** Machine model, 220 pF–240 pF discharged through all pins.

**Note 7:** The given  $\theta_{JA}$  is for an LM4873 packaged in an MXA20A with the Exposed-DAP soldered to an exposed 2in<sup>2</sup> area of 1oz printed circuit board copper.

**Note 8:** The given  $\theta_{JA}$  is for an LM4873 packaged in an MXA20A with the Exposed-DAP soldered to an exposed 1in<sup>2</sup> area of 1oz printed circuit board copper.

**Note 9:** The given  $\theta_{JA}$  is for an LM4873 packaged in an MXA20A with the Exposed-DAP not soldered to printed circuit board copper.

**Note 10:** The given  $\theta_{JA}$  is for an LM4873 packaged in an MXA28A with the Exposed-DAP soldered to an exposed 2in<sup>2</sup> area of 1oz printed circuit board copper.

**Note 11:** The given  $\theta_{JA}$  is for an LM4873 packaged in an MXA28A with the Exposed-DAP soldered to an exposed 1in<sup>2</sup> area of 1oz printed circuit board copper.

**Note 12:** The given  $\theta_{JA}$  is for an LM4873 packaged in an MXA28A with the Exposed-DAP not soldered to printed circuit board copper.

**Note 13:** The given  $\theta_{JA}$  is for an LM4873 packaged in an LQA24A with the Exposed-DAP soldered to an exposed 2in<sup>2</sup> area of 1oz printed circuit board copper.

**Note 14:** The  $\theta_{JA}$  is specified for an LM4873 packaged in a BLA20AAB or TLA20AAA with their four ground connections soldered to a 3in<sup>2</sup>, 1oz copper plane.

**Note 15:** All voltages are measured with respect to the ground (GND) pins, unless otherwise specified.

**Note 16:** Typicals are specified at 25°C and represent the parametric norm.

**Note 17:** Datasheet min/max specification limits are guaranteed by design, test, or statistical analysis.

## Electrical Characteristics for Single-Ended Operation (Notes 3, 15) (Continued)

**Note 18:** The quiescent power supply current depends on the offset voltage when a practical load is connected to the amplifier.

**Note 19:** Output power is measured at the device terminals.

**Note 20:** When driving 3Ω or 4Ω loads and operating on a 5V supply, the LM4873LQ must be mounted to a circuit board that has a minimum of 2.5in<sup>2</sup> of exposed, uninterrupted copper area connected to the LLP package's exposed DAP.

### Typical Performance Characteristics MTE (20-pin) and LQ (24-pin) Specific Characteristics

**LM4873MTE, LM4873LQ  
THD+N vs Output Power**

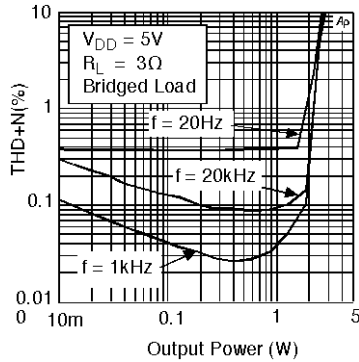

10099333

**LM4873MTE, LM4873LQ  
THD+N vs Frequency**

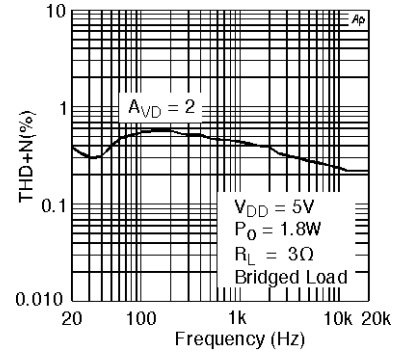

10099334

**LM4873MTE, LM4873LQ  
THD+N vs Output Power**

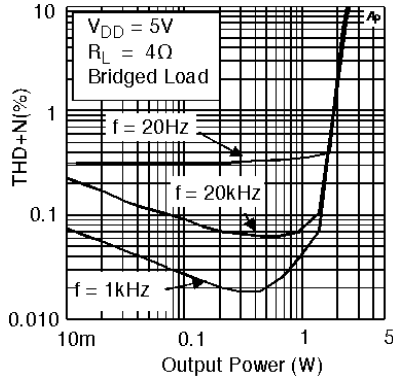

10099336

**LM4873MTE, LM4873LQ  
Power Dissipation vs Power Output**

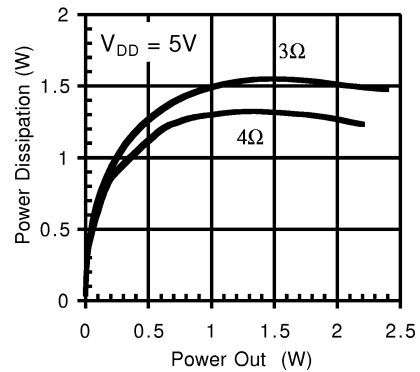

10099390

**LM4873MTE (Note 21)  
Power Derating Curve**

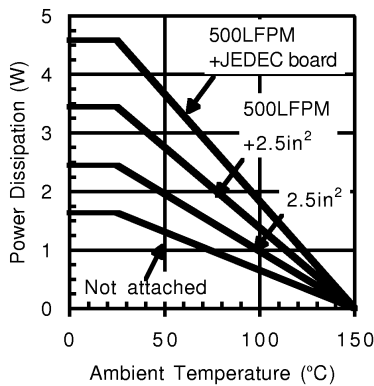

10099395

**LM4873LQ  
Power Derating Curve**

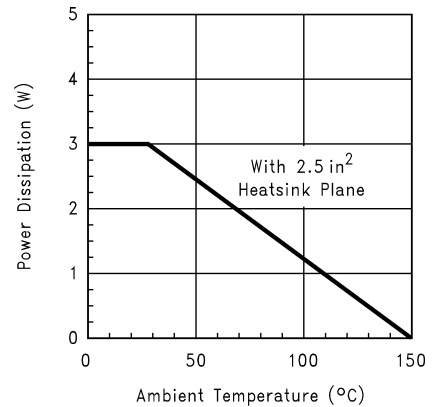

10099356

**Note 21:** This curve shows the LM4873MTE's and the LM4873LQ's thermal dissipation ability at different ambient temperatures given these conditions:

**500LFPM + JEDEC board:** The part is soldered to a 1S2P 20-lead exposed-DAP TSSOP test board with 500 linear feet per minute of forced-air flow across it.

**Board information** - copper dimensions: 74x74mm, copper coverage: 100% (buried layer) and 12% (top/bottom layers), 16 vias under the exposed-DAP.

## Typical Performance Characteristics MTE (20-pin) and LQ (24-pin) Specific Characteristics (Continued)

**500LFPM + 2.5in<sup>2</sup>:** The part is soldered to a 2.5in<sup>2</sup>, 1 oz. copper plane with 500 linear feet per minute of forced-air flow across it.

**2.5in<sup>2</sup>:** The part is soldered to a 2.5in<sup>2</sup>, 1oz. copper plane.

**Not Attached:** The part is not soldered down and is not forced-air cooled.

## Typical Performance Characteristics MTE-1 (28 pin) Specific Characteristics

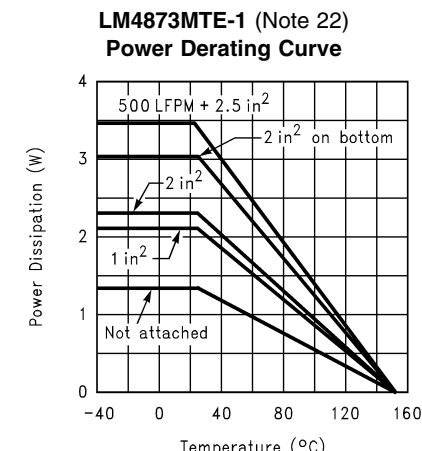
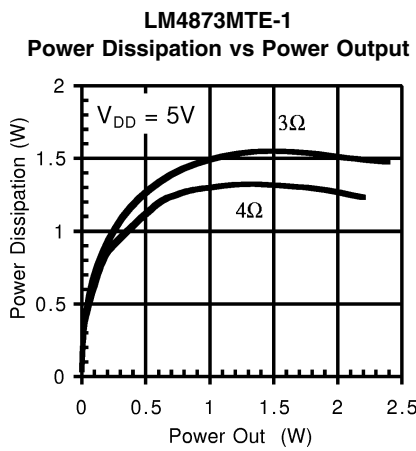
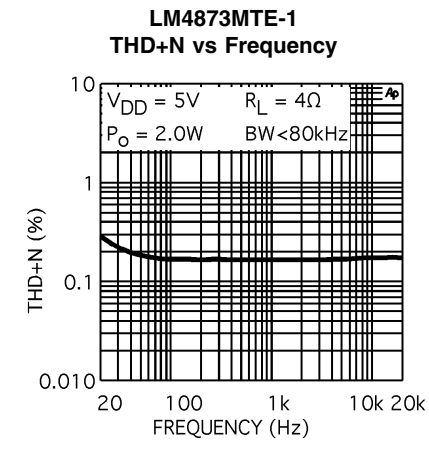
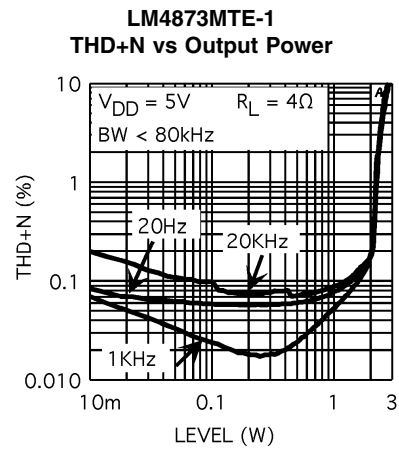
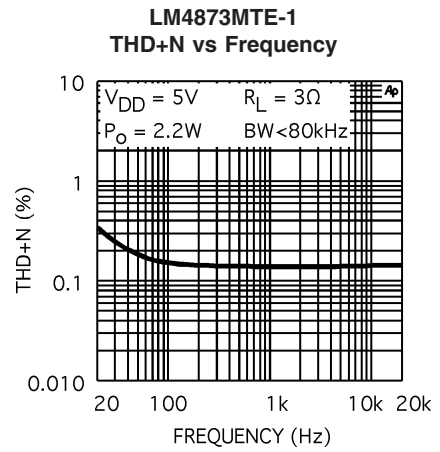
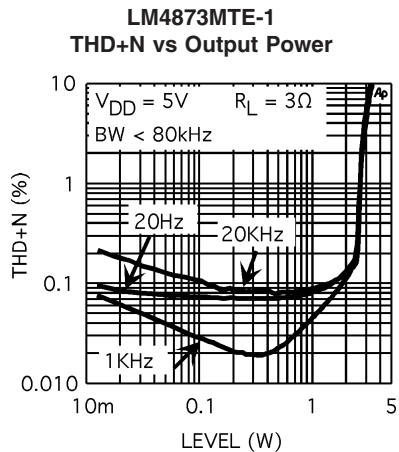

**Note 22:** This curve shows the LM4835MTE-1's thermal dissipation ability at different ambient temperatures given these conditions:

**500LFPM + 2in<sup>2</sup>:** The part is soldered to a 2in<sup>2</sup>, 1 oz. copper plane with 500 linear feet per minute of forced-air flow across it.

# Typical Performance Characteristics MTE-1 (28 pin) Specific Characteristics (Continued)

**2in<sup>2</sup> on bottom:** The part is soldered to a 2in<sup>2</sup>, 1oz. copper plane that is on the bottom side of the PC board through 21 8 mil vias.

**2in<sup>2</sup>:** The part is soldered to a 2in<sup>2</sup>, 1oz. copper plane.

**1in<sup>2</sup>:** The part is soldered to a 1in<sup>2</sup>, 1oz. copper plane.

**Not Attached:** The part is not soldered down and is not forced-air cooled.

## Typical Performance Characteristics

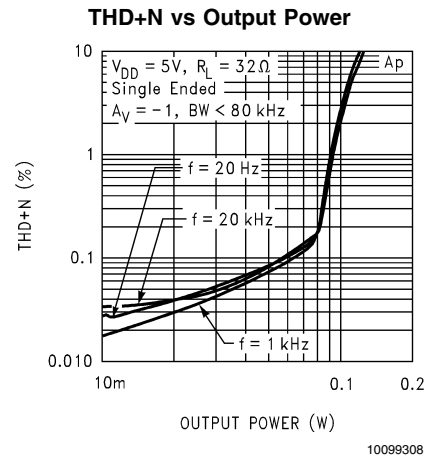
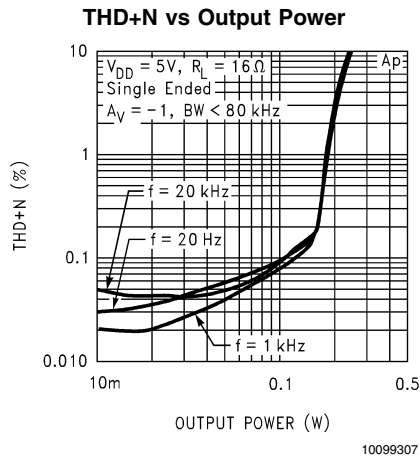
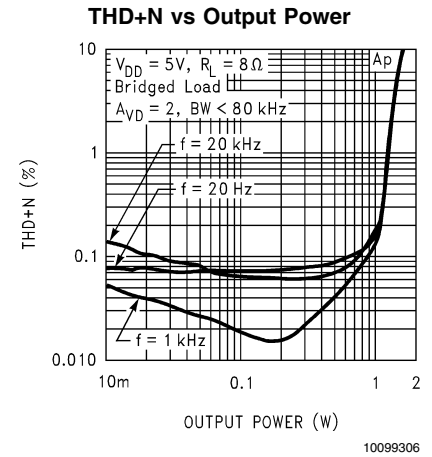
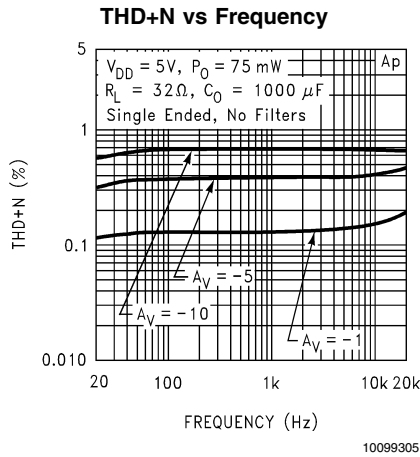
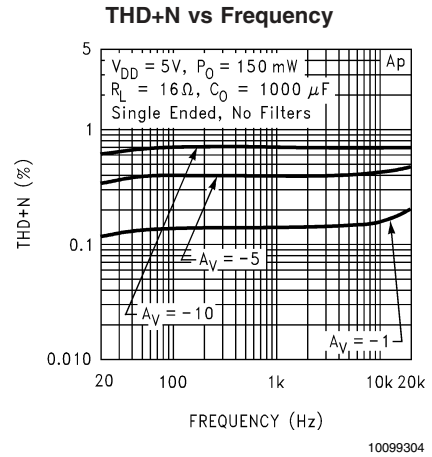
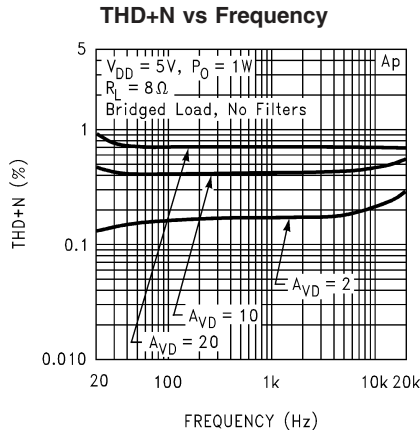



Typical Performance Characteristics (Continued)

THD+N vs Output Power

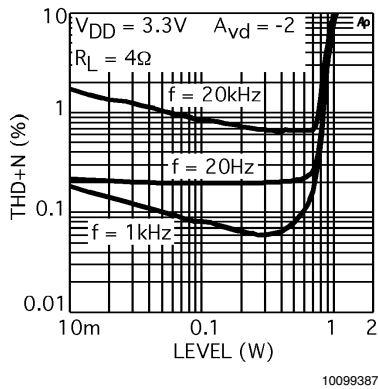

THD+N vs Frequency

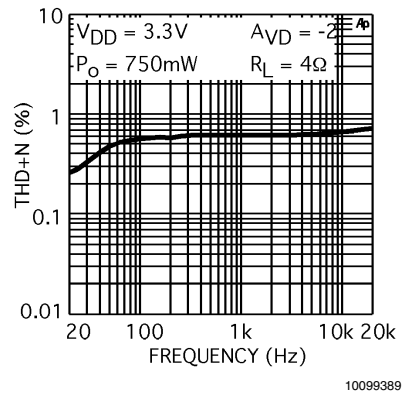

THD+N vs Output Power

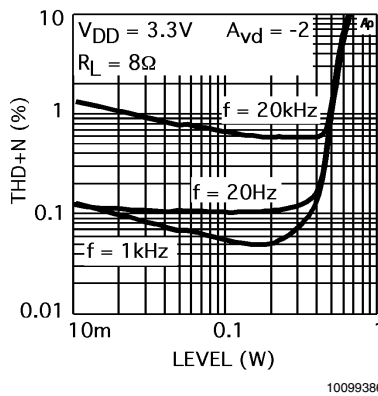

THD+N vs Frequency

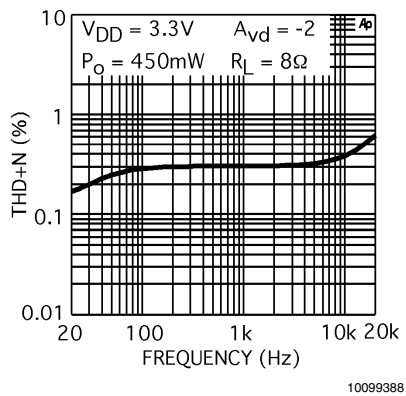

Output Power vs Load Resistance

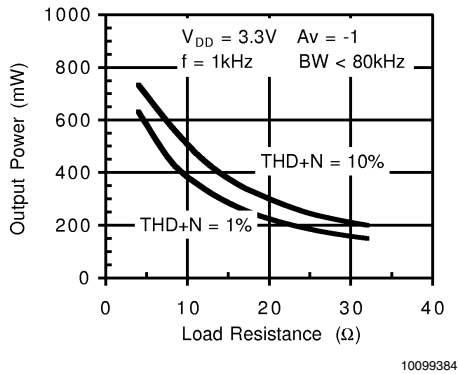

Power Dissipation vs Supply Voltage

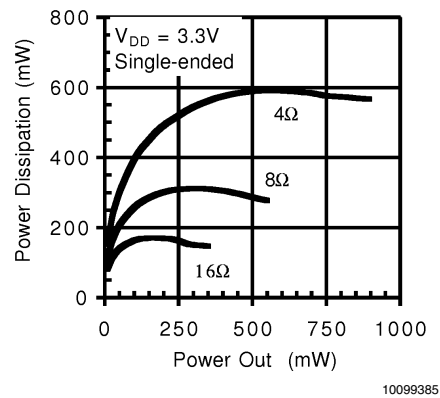

# Typical Performance Characteristics (Continued)

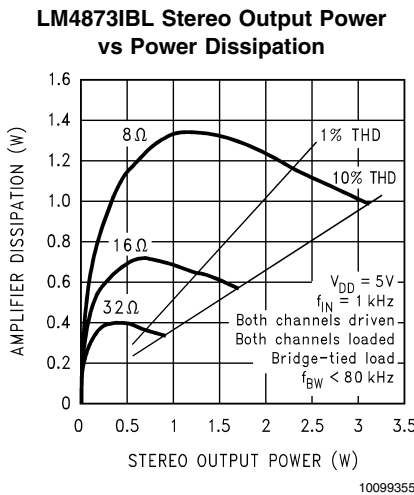
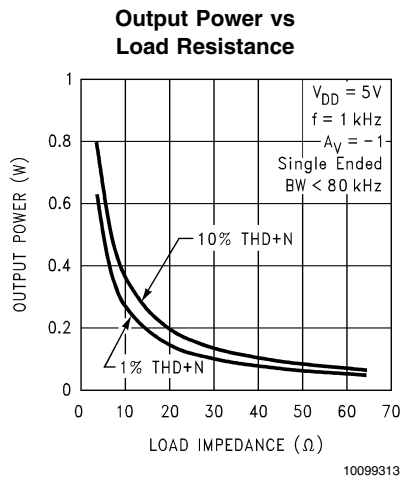
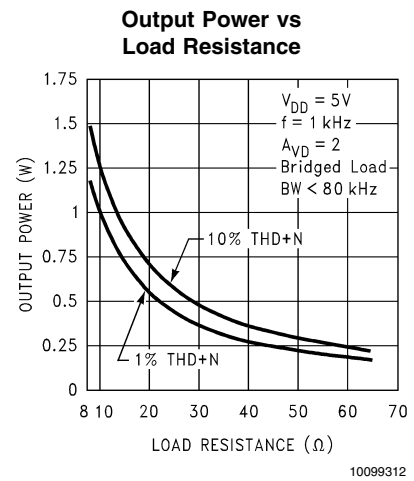
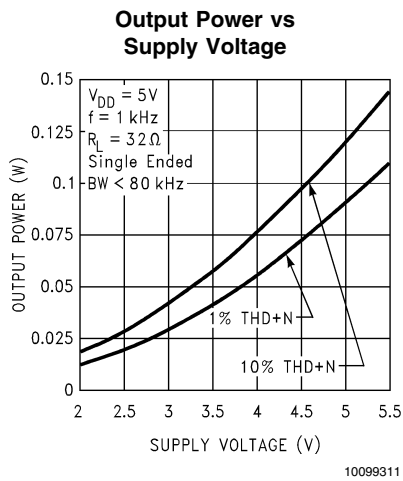
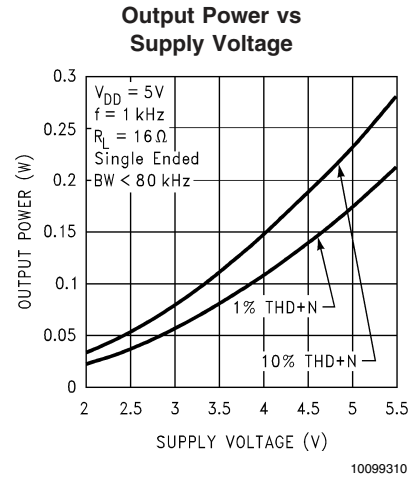
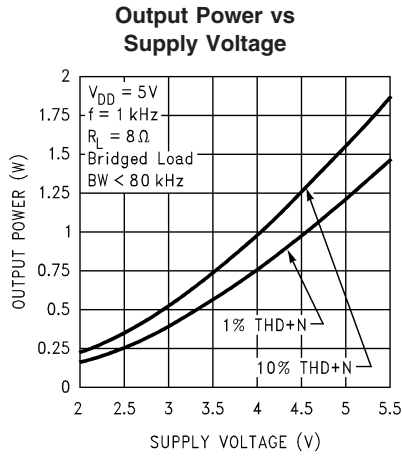

Typical Performance Characteristics (Continued)

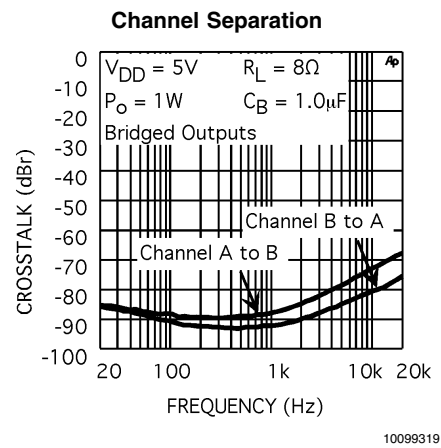
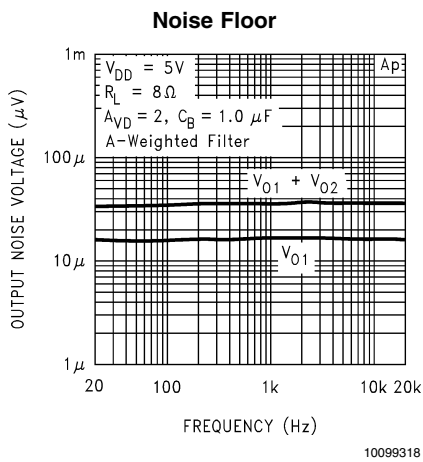
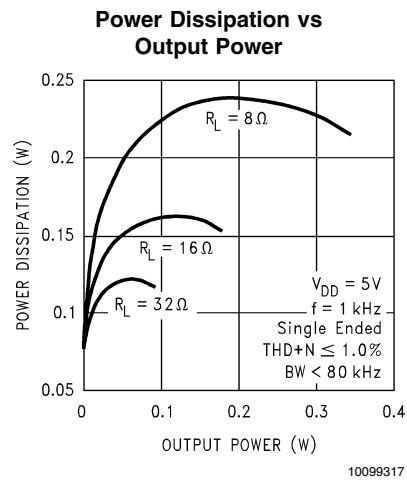
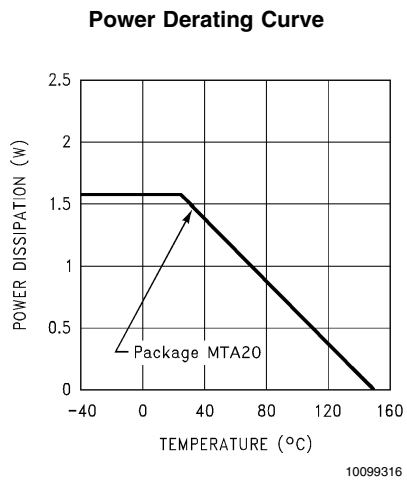
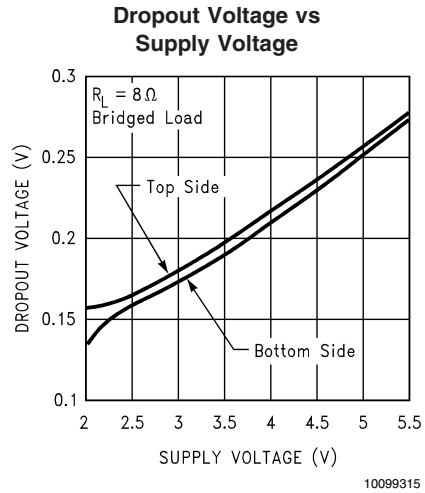
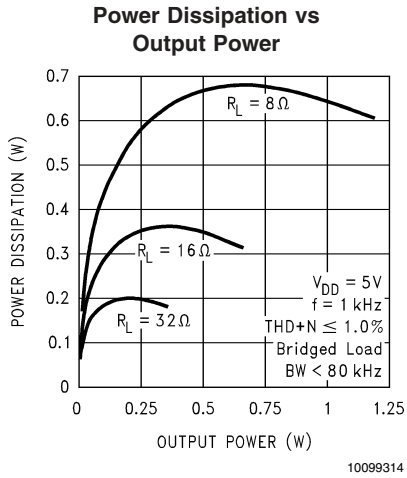

## Typical Performance Characteristics (Continued)

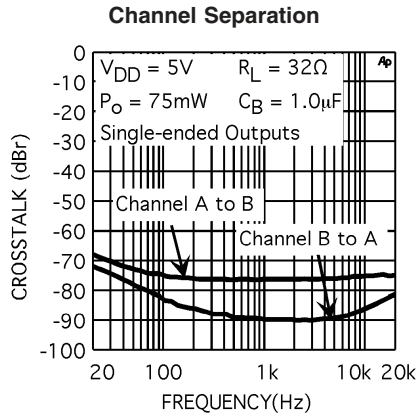

10099320

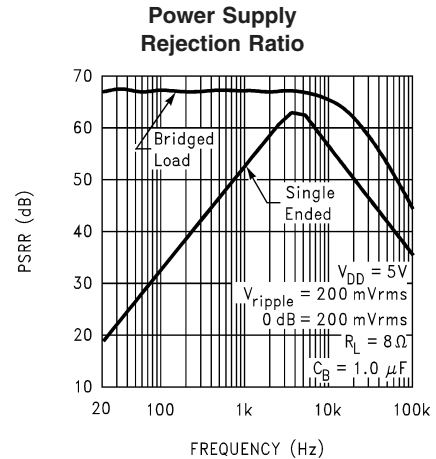

10099321

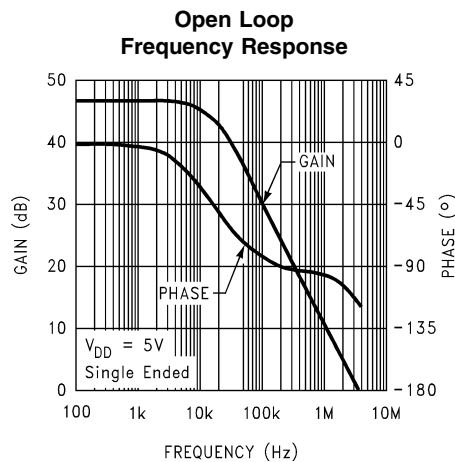

10099322

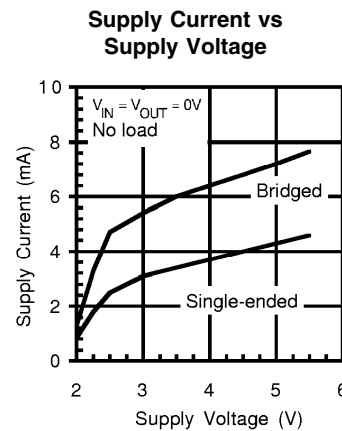

10099323

## External Components Description

(Refer to Figure 1.)

Components	Functional Description
1. $R_i$	The inverting input resistance, along with $R_f$ , set the closed-loop gain. $R_i$ , along with $C_i$ , form a high pass filter with $f_c = 1/(2\pi R_i C_i)$ .
2. $C_i$	The input coupling capacitor blocks DC voltage at the amplifier's input terminals. $C_i$ , along with $R_i$ , create a highpass filter with $f_c = 1/(2\pi R_i C_i)$ . Refer to the section, <b>SELECTING PROPER EXTERNAL COMPONENTS</b> , for an explanation of determining the value of $C_i$ .
3. $R_f$	The feedback resistance, along with $R_i$ , set the closed-loop gain.
4. $C_s$	The supply bypass capacitor. Refer to the <b>POWER SUPPLY BYPASSING</b> section for information about properly placing, and selecting the value of, this capacitor.
5. $C_B$	The capacitor, $C_B$ , filters the half-supply voltage present on the BYPASS pin. Refer to the <b>SELECTING PROPER EXTERNAL COMPONENTS</b> section for information concerning proper placement and selecting $C_B$ 's value.

## Application Information

### LM4863 PIN CONFIGURATION COMPATIBILITY

The LM4873's pin configuration simplifies the process of upgrading systems that use the LM4863. Except for its four MUX function pins, the LM4873's pin configuration matches the LM4863's pin configuration. If the LM4873's MUX functionality is not needed when replacing an LM4863, connect the MUX CTRL pin to either  $V_{DD}$  or ground. As shown in *Table 1*, grounding the MUX CTRL pin selects stereo input 1 (-IN A1 and -IN B1), whereas applying  $V_{DD}$  to the MUX CTRL pin selects stereo input 2 (-IN A2 and -IN B2).

### STEREO-INPUT MULTIPLEXER (STEREO MUX)

Typical LM4873 applications use the MUX to switch between two stereo input signals. Each stereo channel's gain can be tailored to produce the required output signal level. Choosing the input and feedback resistor ratio sets a MUX channel's gain. Another configuration uses the MUX to select two different gains or frequency compensated gains to amplify a single pair of stereo input signals. *Figure 1* shows two different feedback networks, Network 1 and Network 2. Network 1 produces increasing gain as the input signal's frequency decreases. This can be used to compensate a small, full-range speaker's low frequency response roll-off. Network 2 sets the gain for an alternate load such as headphones. Connecting the MUX CTRL and HP-IN pins together applies the same control voltage to the MUX pins when connecting and disconnecting headphones using the headphone jack shown in *Figure 2* or *Figure 3*. Simultaneously applying the control voltage automatically selects the amplifier (headphone or bridge loads) and switches the gain (MUX channel selection). Alternatively, leave the control pins independently accessible. This allows a user to select bass boost as needed. This alternative user-selectable bass-boost scheme requires connecting equal ratio resistor feedback networks to each MUX input channel. The value of the resistor in the RC network is chosen to give a gain that is necessary to achieve the desired bass-boost.

Switching between the MUX channels may change the input signal source or the feedback resistor network. During the channel switching transition, the average voltage level present on the internal amplifier's input may change. This change can slew at a rate that may produce audible voltage transients or clicks in the amplifier's output signal. Using the MUX to select between two vastly dissimilar gains is a typical transient-producing situation. As the MUX is switched, an audible click may occur as the gain suddenly changes.

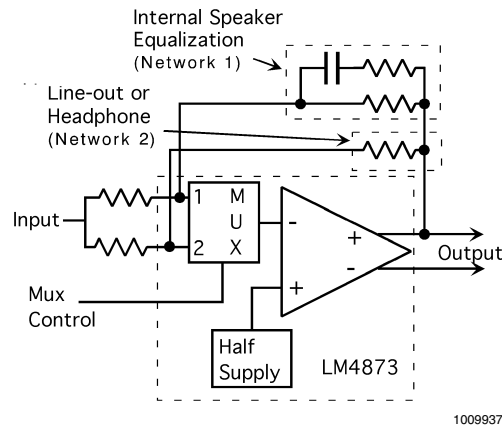

FIGURE 1. Input MUX Example

### micro SMD PACKAGE PCB MOUNTING CONSIDERATIONS

PCB layout specifications unique to the LM4873's micro SMD package are found in National Semiconductor's AN1112.

### EXPOSED-DAP PACKAGE PCB MOUNTING CONSIDERATIONS

The LM4873's exposed-DAP (die attach paddle) packages (MTE, MTE-1, LQ) provide a low thermal resistance between the die and the PCB to which the part is mounted and soldered. This allows rapid heat transfer from the die to the surrounding PCB copper traces, ground plane and, finally, surrounding air. The result is a low voltage audio power amplifier that produces 2.1W at  $\leq 1\%$  THD with a 4 $\Omega$  load. This high power is achieved through careful consideration of necessary thermal design. Failing to optimize thermal design may compromise the LM4873's high power performance and activate unwanted, though necessary, thermal shutdown protection.

The MTE, MTE-1, and LQ packages must have their DAPs soldered to a copper pad on the PCB. The DAP's PCB copper pad is connected to a large plane of continuous unbroken copper. This plane forms a thermal mass and heat sink and radiation area. Place the heat sink area on either outside plane in the case of a two-sided PCB, or on an inner layer of a board with more than two layers. Connect the DAP copper pad to the inner layer or backside copper heat sink area with 32(4x8) (MTE), 40(4x10) (MTE-1), or 6(3x2) (LQ) vias. The via diameter should be 0.012in–0.013in with a 1.27mm pitch. Ensure efficient thermal conductivity by plating-through and solder-filling the vias.

Best thermal performance is achieved with the largest practical copper heat sink area. If the heatsink and amplifier share the same PCB layer, a nominal 2.5in<sup>2</sup> (min) area is necessary for 5V operation with a 4 $\Omega$  load. Heatsink areas not placed on the same PCB layer as the LM4873 should be 5in<sup>2</sup> (min) for the same supply voltage and load resistance. The last two area recommendations apply for 25°C ambient temperature. Increase the area to compensate for ambient temperatures above 25°C. In systems using cooling fans, the LM4873MTE can take advantage of forced air cooling. With an air flow rate of 450 linear-feet per minute and a 2.5in<sup>2</sup> exposed copper or 5.0in<sup>2</sup> inner layer copper plane heatsink, the LM4873MTE can continuously drive a 3 $\Omega$  load to full

## Application Information (Continued)

power. The LM4873LQ achieves the same output power level without forced air cooling. In all circumstances and conditions, the junction temperature must be held below 150°C to prevent activating the LM4873's thermal shutdown protection. The LM4873's power de-rating curve in the **Typical Performance Characteristics** shows the maximum power dissipation versus temperature. Example PCB layouts for the exposed-DAP TSSOP and LQ packages are shown in the **Demonstration Board Layout** section. Further detailed and specific information concerning PCB layout, fabrication, and mounting an LQ (LLP) package is available from National Semiconductor's AN1187.

### PCB LAYOUT AND SUPPLY REGULATION CONSIDERATIONS FOR DRIVING 3Ω AND 4Ω LOADS

Power dissipated by a load is a function of the voltage swing across the load and the load's impedance. As load impedance decreases, load dissipation becomes increasingly dependent on the interconnect (PCB trace and wire) resistance

between the amplifier output pins and the load's connections. Residual trace resistance causes a voltage drop, which results in power dissipated in the trace and not in the load as desired. For example, 0.1Ω trace resistance reduces the output power dissipated by a 4Ω load from 2.1W to 2.0W. This problem of decreased load dissipation is exacerbated as load impedance decreases. Therefore, to maintain the highest load dissipation and widest output voltage swing, PCB traces that connect the output pins to a load must be as wide as possible.

Poor power supply regulation adversely affects maximum output power. A poorly regulated supply's output voltage decreases with increasing load current. Reduced supply voltage causes decreased headroom, output signal clipping, and reduced output power. Even with tightly regulated supplies, trace resistance creates the same effects as poor supply regulation. Therefore, making the power supply traces as wide as possible helps maintain full output voltage swing.

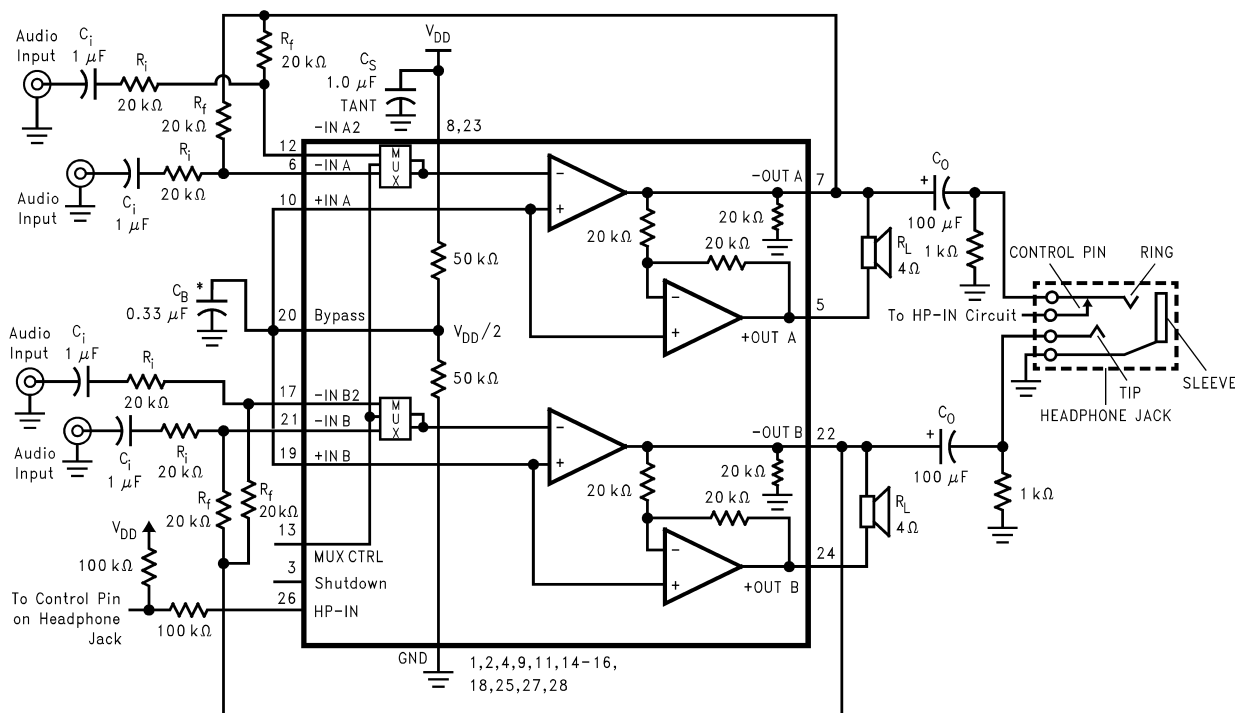

\* Refer to the section Selecting Proper External Components, for a detailed discussion of  $C_B$  size.

10099331

**FIGURE 2. Typical Audio Amplifier Application Circuit**  
Pin out shown for the 28-pin Exposed-DAP TSSOP package. Refer to the Connection Diagrams for the pin out of the 20-pin Exposed-DAP TSSOP, Exposed-DAP LLP, and micro SMD package.

### BRIDGE CONFIGURATION EXPLANATION

As shown in *Figure 2*, the LM4873 consists of two pairs of operational amplifiers, forming a two-channel (channel A and channel B) stereo amplifier. (Though the following discusses channel A, it applies equally to channel B.) External resistors  $R_f$  and  $R_i$  set the closed-loop gain of Amp1A, whereas two internal 20kΩ resistors set Amp2A's gain at  $-1$ . The LM4873 drives a load, such as a speaker, connected between the two amplifier outputs,  $-OUTA$  and  $+OUTA$ .

*Figure 2* shows that Amp1A's output serves as Amp2A's input. This results in both amplifiers producing signals identical in magnitude, but 180° out of phase. Taking advantage of this phase difference, a load is placed between  $-OUTA$  and  $+OUTA$  and driven differentially (commonly referred to as "bridge mode"). This results in a differential gain of

$$A_{VD} = 2 * (R_f/R_i) \quad (1)$$

Bridge mode amplifiers are different from single-ended amplifiers that drive loads connected between a single amplifier's output and ground. For a given supply voltage, bridge

## Application Information (Continued)

mode has a distinct advantage over the single-ended configuration: its differential output doubles the voltage swing across the load. This produces four times the output power when compared to a single-ended amplifier under the same conditions. This increase in attainable output power assumes that the amplifier is not current limited or that the output signal is not clipped. To ensure minimum output signal clipping when choosing an amplifier's closed-loop gain, refer to the **Audio Power Amplifier Design** section.

Another advantage of the differential bridge output is no net DC voltage across the load. This is accomplished by biasing channel A's and channel B's outputs at half-supply. This eliminates the coupling capacitor that single supply, single-ended amplifiers require. Eliminating an output coupling capacitor in a single-ended configuration forces a single-supply amplifier's half-supply bias voltage across the load. This increases internal IC power dissipation and may permanently damage loads such as speakers.

### POWER DISSIPATION

Power dissipation is a major concern when designing a successful single-ended or bridged amplifier. Equation (2) states the maximum power dissipation point for a single-ended amplifier operating at a given supply voltage and driving a specified output load.

$$P_{\text{DMAX}} = (V_{\text{DD}})^2 / (2\pi^2 R_L) \quad \text{Single-Ended} \quad (2)$$

However, a direct consequence of the increased power delivered to the load by a bridge amplifier is higher internal power dissipation for the same conditions.

The LM4873 has two operational amplifiers per channel. The maximum internal power dissipation per channel operating in the bridge mode is four times that of a single-ended amplifier. From Equation (3), assuming a 5V power supply and a 4Ω load, the maximum single channel power dissipation is 1.27W or 2.54W for stereo operation.

$$P_{\text{DMAX}} = 4 * (V_{\text{DD}})^2 / (2\pi^2 R_L) \quad \text{Bridge Mode} \quad (3)$$

The LM4873's power dissipation is twice that given by Equation (2) or Equation (3) when operating in the single-ended mode or bridge mode, respectively. Twice the maximum power dissipation point given by Equation (3) must not exceed the power dissipation given by Equation (4):

$$P_{\text{DMAX}}' = (T_{\text{JMAX}} - T_A) / \theta_{\text{JA}} \quad (4)$$

The LM4873's  $T_{\text{JMAX}} = 150^\circ\text{C}$ . In the LQ package soldered to a DAP pad that expands to a copper area of  $5\text{in}^2$  on a PCB, the LM4873's  $\theta_{\text{JA}}$  is  $20^\circ\text{C/W}$ . In the MTE and MTE-1 packages soldered to a DAP pad that expands to a copper area of  $2\text{in}^2$  on a PCB, the LM4873's  $\theta_{\text{JA}}$  is  $41^\circ\text{C/W}$ . At any given ambient temperature  $T_A$ , use Equation (4) to find the maximum internal power dissipation supported by the IC packaging. Rearranging Equation (4) and substituting  $P_{\text{DMAX}}$  for  $P_{\text{DMAX}}'$  results in Equation (5). This equation gives the maximum ambient temperature that still allows maximum stereo power dissipation without violating the LM4873's maximum junction temperature.

$$T_A = T_{\text{JMAX}} - 2 * P_{\text{DMAX}} \theta_{\text{JA}} \quad (5)$$

For a typical application with a 5V power supply and an 4Ω load, the maximum ambient temperature that allows maximum stereo power dissipation without exceeding the maximum junction temperature is approximately  $99^\circ\text{C}$  for the LQ package and  $45^\circ\text{C}$  for the MTE and MTE-1 packages.

$$T_{\text{JMAX}} = P_{\text{DMAX}} \theta_{\text{JA}} + T_A \quad (6)$$

Equation (6) gives the maximum junction temperature  $T_{\text{JMAX}}$ . If the result violates the LM4873's  $150^\circ\text{C}$ , reduce the maximum junction temperature by reducing the power supply voltage or increasing the load resistance. Further allowance should be made for increased ambient temperatures.

The above examples assume that a device is a surface mount part operating around the maximum power dissipation point. Since internal power dissipation is a function of output power, higher ambient temperatures are allowed as output power or duty cycle decreases.

If the result of Equation (2) is greater than that of Equation (3), then decrease the supply voltage, increase the load impedance, or reduce the ambient temperature. If these measures are insufficient, a heat sink can be added to reduce  $\theta_{\text{JA}}$ . The heat sink can be created using additional copper area around the package, with connections to the ground pin(s), supply pin and amplifier output pins. External, solder attached SMT heatsinks such as the Thermalloy 7106D can also improve power dissipation. When adding a heat sink, the  $\theta_{\text{JA}}$  is the sum of  $\theta_{\text{JC}}$ ,  $\theta_{\text{CS}}$ , and  $\theta_{\text{SA}}$ . ( $\theta_{\text{JC}}$  is the junction-to-case thermal impedance,  $\theta_{\text{CS}}$  is the case-to-sink thermal impedance, and  $\theta_{\text{SA}}$  is the sink-to-ambient thermal impedance.) Refer to the **Typical Performance Characteristics** curves for power dissipation information at lower output power levels.

### POWER SUPPLY BYPASSING

As with any power amplifier, proper supply bypassing is critical for low noise performance and high power supply rejection. Applications that employ a 5V regulator typically use a 10 μF in parallel with a 0.1 μF filter capacitors to stabilize the regulator's output, reduce noise on the supply line, and improve the supply's transient response. However, their presence does not eliminate the need for a local 1.0 μF tantalum bypass capacitance connected between the LM4873's supply pins and ground. Do not substitute a ceramic capacitor for the tantalum. Doing so may cause oscillation. Keep the length of leads and traces that connect capacitors between the LM4873's power supply pin and ground as short as possible. Connecting a 1μF capacitor,  $C_B$ , between the BYPASS pin and ground improves the internal bias voltage's stability and improves the amplifier's PSRR. The PSRR improvements increase as the bypass pin capacitor value increases. Too large, however, increases turn-on time and can compromise amplifier's click and pop performance. The selection of bypass capacitor values, especially  $C_B$ , depends on desired PSRR requirements, click and pop performance (as explained in the section, **Selecting Proper External Components**), system cost, and size constraints.

### MICRO-POWER SHUTDOWN

The voltage applied to the SHUTDOWN pin controls the LM4873's shutdown function. Activate micro-power shutdown by applying  $V_{\text{DD}}$  to the SHUTDOWN pin. When active, the LM4873's micro-power shutdown feature turns off the amplifier's bias circuitry, reducing the supply current. The logic threshold is typically  $V_{\text{DD}}/2$ . The low 0.7 μA typical shutdown current is achieved by applying a voltage that is as near as  $V_{\text{DD}}$  as possible to the SHUTDOWN pin. A voltage that is less than  $V_{\text{DD}}$  may increase the shutdown current. *Table 1* shows the logic signal levels that activate and deactivate micro-power shutdown and headphone amplifier operation.

There are a few ways to control the micro-power shutdown. These include using a single-pole, single-throw switch, a

## Application Information (Continued)

microprocessor, or a microcontroller. When using a switch, connect an external 10k $\Omega$  pull-up resistor between the SHUTDOWN pin and  $V_{DD}$ . Connect the switch between the SHUTDOWN pin and ground. Select normal amplifier operation by closing the switch. Opening the switch connects the SHUTDOWN pin to  $V_{DD}$  through the pull-up resistor, activating

micro-power shutdown. The switch and resistor guarantee that the SHUTDOWN pin will not float. This prevents unwanted state changes. In a system with a microprocessor or a microcontroller, use a digital output to apply the control voltage to the SHUTDOWN pin. Driving the SHUTDOWN pin with active circuitry eliminates the pull up resistor.

**TABLE 1. Logic Level Truth Table for SHUTDOWN, HP-IN, and MUX Operation**

SHUTDOWN PIN	HP-INPIN	MUX CHANNEL SELECT PIN	OPERATIONAL MODE (MUX INPUT CHANNEL #)
Logic Low	Logic Low	Logic Low	Bridged Amplifiers (1)
Logic Low	Logic Low	Logic High	Bridged Amplifiers (2)
Logic Low	Logic High	Logic Low	Single-Ended Amplifiers (1)
Logic Low	Logic High	Logic High	Single-Ended Amplifiers (2)
Logic High	X	X	Micro-Power Shutdown

### HP-IN FUNCTION

Applying a voltage between 4V and  $V_{DD}$  to the LM4873's HP-IN headphone control pin turns off Amp2A and Amp2B, muting a bridged-connected load. Quiescent current consumption is reduced when the IC is in this single-ended mode.

Figure 3 shows the implementation of the LM4873's headphone control function. With no headphones connected to the headphone jack, the R1-R2 voltage divider sets the voltage applied to the HP-IN pin (pin 16) at approximately 50mV. This 50mV enables Amp1B and Amp2B, placing the LM4873 in bridged mode operation. The output coupling capacitor blocks the amplifier's half supply DC voltage, protecting the headphones.

The HP-IN threshold is set at 4V. While the LM4873 operates in bridged mode, the DC potential across the load is essentially 0V. Therefore, even in an ideal situation, the output swing cannot cause a false single-ended trigger. Connecting headphones to the headphone jack disconnects the headphone jack contact pin from -OUTA and allows R1 to pull the HP Sense pin up to  $V_{DD}$ . This enables the headphone function, turns off Amp2A and Amp2B, and mutes the bridged speaker. The amplifier then drives the headphones, whose impedance is in parallel with resistor R2 and R3. These resistors have negligible effect on the LM4873's output drive capability since the typical impedance of headphones is 32 $\Omega$ .

Figure 3 also shows the suggested headphone jack electrical connections. The jack is designed to mate with a three-wire plug. The plug's tip and ring should each carry one of the two stereo output signals, whereas the sleeve should carry the ground return. A headphone jack with one control pin contact is sufficient to drive the HP-IN pin when connecting headphones.

A microprocessor or a switch can replace the headphone jack contact pin. When a microprocessor or switch applies a voltage greater than 4V to the HP-IN pin, a bridge-connected speaker is muted and Amp1A and Amp2A drive a pair of headphones.

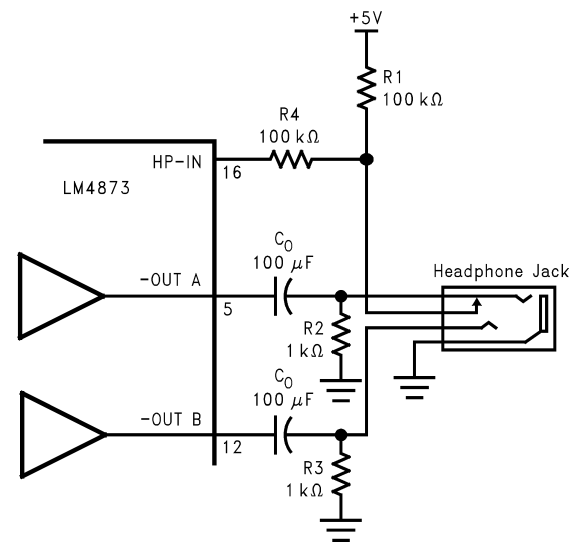

10099324

**FIGURE 3. Headphone Circuit**

### SELECTING PROPER EXTERNAL COMPONENTS

Optimizing the LM4873's performance requires properly selecting external components. Though the LM4873 operates well when using external components with wide tolerances, best performance is achieved by optimizing component values.

The LM4873 is unity-gain stable, giving a designer maximum design flexibility. The gain should be set to no more than a given application requires. This allows the amplifier to achieve minimum THD+N and maximum signal-to-noise ratio. These parameters are compromised as the closed-loop gain increases. However, low gain demands input signals with greater voltage swings to achieve maximum output power. Fortunately, many signal sources such as audio CODECs have outputs of 1V<sub>RMS</sub> (2.83V<sub>P-P</sub>). Please refer to the **Audio Power Amplifier Design** section for more information on selecting the proper gain.



## Application Information (Continued)

### Input Capacitor Value Selection

Amplifying the lowest audio frequencies requires high value input coupling capacitor ( $C_i$  in *Figure 2*). A high value capacitor can be expensive and may compromise space efficiency in portable designs. In many cases, however, the speakers used in portable systems, whether internal or external, have little ability to reproduce signals below 150 Hz. Applications using speakers with this limited frequency response reap little improvement by using large input capacitor.

Besides effecting system cost and size,  $C_i$  has an affect on the LM4873's click and pop performance. When the supply voltage is first applied, a transient (pop) is created as the charge on the input capacitor changes from zero to a quiescent state. The magnitude of the pop is directly proportional to the input capacitor's size. Higher value capacitors need more time to reach a quiescent DC voltage (usually  $V_{DD}/2$ ) when charged with a fixed current. The amplifier's output charges the input capacitor through the feedback resistor,  $R_f$ . Thus, pops can be minimized by selecting an input capacitor value that is no higher than necessary to meet the desired  $-3\text{dB}$  frequency.

As shown in *Figure 2*, the input resistor ( $R_i$ ) and the input capacitor,  $C_i$  produce a  $-3\text{dB}$  high pass filter cutoff frequency that is found using Equation (7).

$$f_{-3\text{dB}} = \frac{1}{2\pi R_i C_i} \quad (7)$$

As an example when using a speaker with a low frequency limit of 150Hz,  $C_i$ , using Equation (4) is  $0.063\mu\text{F}$ . The  $1.0\mu\text{F}$   $C_i$  shown in *Figure 2* allows the LM4873 to drive high efficiency, full range speaker whose response extends below 30Hz.

### Bypass Capacitor Value Selection

Besides minimizing the input capacitor size, careful consideration should be paid to value of  $C_B$ , the capacitor connected to the BYPASS pin. Since  $C_B$  determines how fast the LM4873 settles to quiescent operation, its value is critical when minimizing turn-on pops. The slower the LM4873's outputs ramp to their quiescent DC voltage (nominally  $1/2 V_{DD}$ ), the smaller the turn-on pop. Choosing  $C_B$  equal to  $1.0\mu\text{F}$  along with a small value of  $C_i$  (in the range of  $0.1\mu\text{F}$  to  $0.39\mu\text{F}$ ), produces a click-less and pop-less shutdown function. As discussed above, choosing  $C_i$  no larger than necessary for the desired bandwidth helps minimize clicks and pops.

### OPTIMIZING CLICK AND POP REDUCTION PERFORMANCE

The LM4873 contains circuitry that minimizes turn-on and shutdown transients or "clicks and pop". For this discussion, turn-on refers to either applying the power supply voltage or when the shutdown mode is deactivated. While the power supply is ramping to its final value, the LM4873's internal amplifiers are configured as unity gain buffers. An internal current source changes the voltage of the BYPASS pin in a controlled, linear manner. Ideally, the input and outputs track the voltage applied to the BYPASS pin. The gain of the internal amplifiers remains unity until the voltage on the bypass pin reaches  $1/2 V_{DD}$ . As soon as the voltage on the bypass pin is stable, the device becomes fully operational. Although the BYPASS pin current cannot be modified, changing the size of  $C_B$  alters the device's turn-on time and

the magnitude of "clicks and pops". Increasing the value of  $C_B$  reduces the magnitude of turn-on pops. However, this presents a tradeoff: as the size of  $C_B$  increases, the turn-on time increases. There is a linear relationship between the size of  $C_B$  and the turn-on time. Here are some typical turn-on times for various values of  $C_B$ :

$C_B$	$T_{ON}$
$0.01\mu\text{F}$	20ms
$0.1\mu\text{F}$	200ms
$0.22\mu\text{F}$	440ms
$0.47\mu\text{F}$	940ms
$1.0\mu\text{F}$	2sec

In order eliminate "clicks and pops", all capacitors must be discharged before turn-on. Rapidly switching  $V_{DD}$  may not allow the capacitors to fully discharge, which may cause "clicks and pops". In a single-ended configuration, the output is coupled to the load by  $C_{OUT}$ . This capacitor usually has a high value.  $C_{OUT}$  discharges through internal  $20\text{k}\Omega$  resistors. Depending on the size of  $C_{OUT}$ , the discharge time constant can be relatively large. To reduce transients in single-ended mode, an external  $1\text{k}\Omega$ – $5\text{k}\Omega$  resistor can be placed in parallel with the internal  $20\text{k}\Omega$  resistor. The tradeoff for using this resistor is increased quiescent current.

### NO LOAD STABILITY

The LM4873 may exhibit low level oscillation when the load resistance is greater than  $10\text{k}\Omega$ . This oscillation only occurs as the output signal swings near the supply voltages. Prevent this oscillation by connecting a  $5\text{k}\Omega$  between the output pins and ground.

### AUDIO POWER AMPLIFIER DESIGN

#### Audio Amplifier Design: Driving 1W into an $8\Omega$ Load

The following are the desired operational parameters:

Power Output:	$1W_{RMS}$
Load Impedance:	$8\Omega$
Input Level:	$1V_{rms}$
Input Impedance:	$20\text{k}\Omega$
Bandwidth:	$100\text{Hz} - 20\text{kHz} \pm 0.25\text{dB}$

The design begins by specifying the minimum supply voltage necessary to obtain the specified output power. One way to find the minimum supply voltage is to use the Output Power vs Supply Voltage curve in the **Typical Performance Characteristics** section. Another way, using Equation (8), is to calculate the peak output voltage necessary to achieve the desired output power for a given load impedance. To account for the amplifier's dropout voltage, two additional voltages, based on the Dropout Voltage vs Supply Voltage in the **Typical Performance Characteristics** curves, must be added to the result obtained by Equation (8). The result in Equation (9).

$$V_{OUTPEAK} = \sqrt{(2R_L P_O)} \quad (8)$$

$$V_{DD} \geq (V_{OUTPEAK} + (V_{ODTOP} + V_{ODBOT})) \quad (9)$$

The Output Power vs Supply Voltage graph for an  $8\Omega$  load indicates a minimum supply voltage of  $4.6\text{V}$ . This is easily met by the commonly used  $5\text{V}$  supply voltage. The additional voltage creates the benefit of headroom, allowing the LM4873 to produce peak output power in excess of  $1\text{W}$

## Application Information (Continued)

without clipping or other audible distortion. The choice of supply voltage must also not create a situation that violates maximum power dissipation as explained above in the **Power Dissipation** section.

After satisfying the LM4873's power dissipation requirements, the minimum differential gain needed to achieve 1W dissipation in an 8Ω load is found using Equation (10).

$$A_{VD} \geq \sqrt{(P_O R_L) / (V_{IN})} = V_{orms} / V_{inrms} \quad (10)$$

Thus, a minimum gain of 2.83 allows the LM4873's to reach full output swing and maintain low noise and THD+N performance. For this example, let  $A_{VD} = 3$ .

The amplifier's overall gain is set using the input ( $R_i$ ) and feedback ( $R_f$ ) resistors. With the desired input impedance set at 20kΩ, the feedback resistor is found using Equation (11).

$$R_f / R_i = A_{VD} / 2 \quad (11)$$

The value of  $R_f$  is 30kΩ.

The last step in this design example is setting the amplifier's -3dB frequency bandwidth. To achieve the desired ±0.25dB pass band magnitude variation limit, the low frequency response must extend to at least one-fifth the lower bandwidth limit and the high frequency response must extend to at least five times the upper bandwidth limit. The gain variation for both response limits is 0.17dB, well within the ±0.25dB desired limit. The results are an

$$f_L = 100\text{Hz} / 5 = 20\text{Hz}$$

and an

$$f_H = 20\text{kHz} * 5 = 100\text{kHz}.$$

As mentioned in the **External Components** section,  $R_i$  and  $C_i$  create a highpass filter that sets the amplifier's lower bandpass frequency limit. Find the coupling capacitor's value using Equation (12).

$$C_i \geq 1 / (2\pi R_i f_L) \quad (12)$$

The result is

$$1 / (2\pi * 20\text{k}\Omega * 20\text{Hz}) = 0.398\mu\text{F}.$$

Use a 0.39μF capacitor, the closest standard value.

The product of the desired high frequency cutoff (100kHz in this example) and the differential gain,  $A_{VD}$ , determines the upper passband response limit. With  $A_{VD} = 3$  and  $f_H = 100\text{kHz}$ , the closed-loop gain bandwidth product (GBWP) is 300kHz. This is less than the LM4873's 3.5MHz GBWP. With this margin, the amplifier can be used in designs that require more differential gain while avoiding performance-restricting bandwidth limitations.

### RECOMMENDED PRINTED CIRCUIT BOARD LAYOUT

Figures 4 through 6 show the recommended two-layer PC board layout that is optimized for the 20-pin MTE-packaged LM4873 and associated external components. Figures 7 through 11 show the recommended four-layer PC board layout that is optimized for the 24-pin LQ-packaged LM4873 and associated external components. Figures 12 through 16 show the recommended four-layer PC board layout that is optimized for the 20-pin micro SMD-packaged LM4873 and associated external components. These circuits are designed for use with an external 5V supply and 4Ω speakers.

These circuit boards are easy to use. Apply 5V and ground to the board's  $V_{DD}$  and GND pads, respectively. Connect 4Ω speakers between the board's -OUTA and +OUTA and OUTB and +OUTB pads.

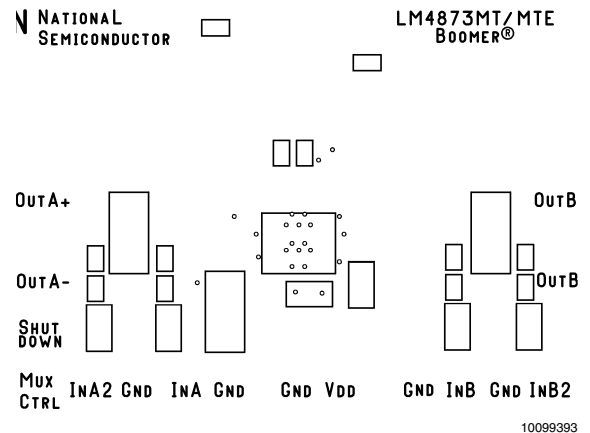

FIGURE 4. Recommended MTE PC Board Layout: Component-Side Silkscreen

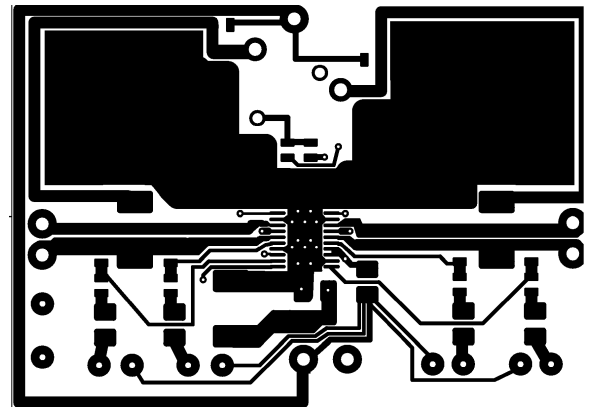

FIGURE 5. Recommended MTE PC Board Layout: Component-Side Layout

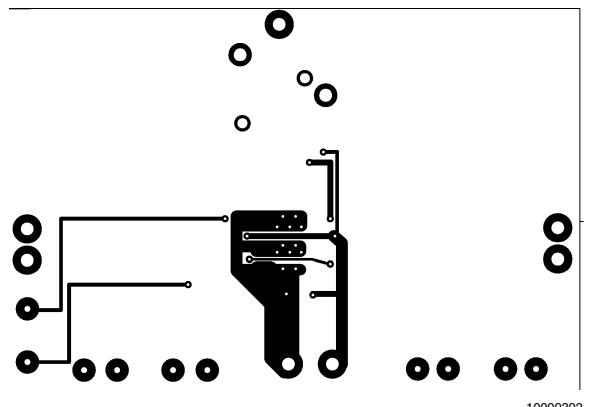
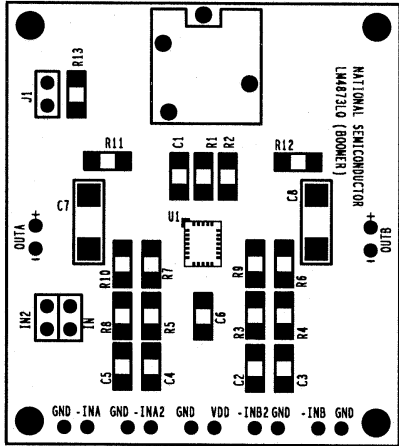

FIGURE 6. Recommended MTE PC Board Layout: Bottom-Side Layout

Application Information (Continued)



10099339

Figure 7. Recommended LQ PC Board Layout: Component-Side Silkscreen

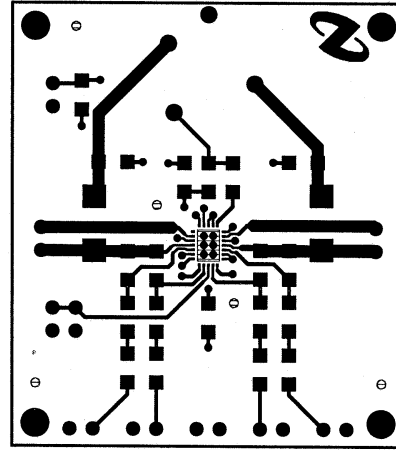

10099340

Figure 8. Recommended LQ PC Board Layout: Component-Side Layout

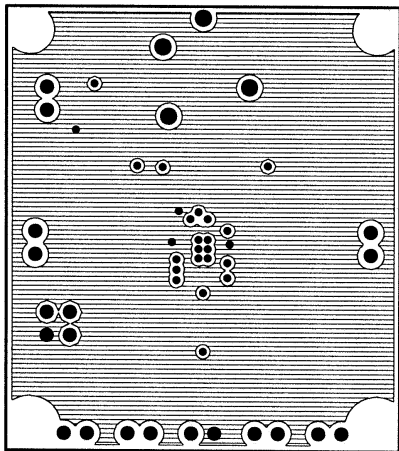

10099341

Figure 9. Recommended LQ PC Board Layout: Upper Inner-Layer Layout

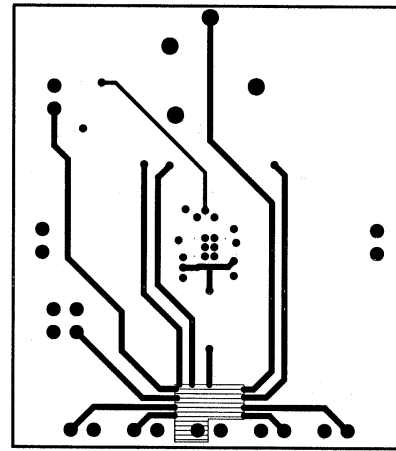

10099342

Figure 10. Recommended LQ PC Board Layout: Lower Inner-Layer Layout

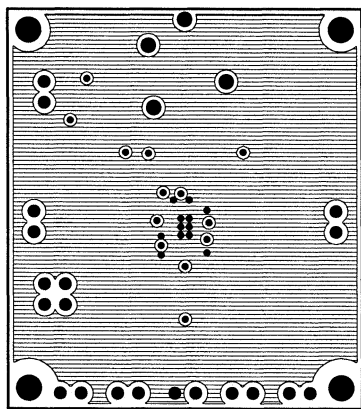

10099343

Figure 11. Recommended LQ PC Board Layout: Bottom-Side Layout

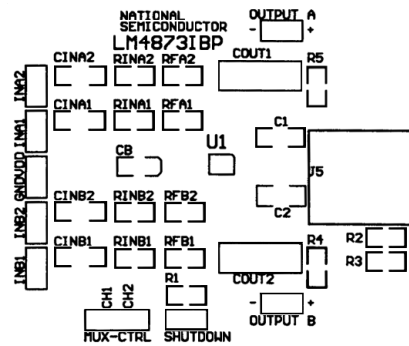

10099344

Figure 12. Recommended 20-pin micro SMD PC Board Layout: Component-Side Silkscreen

**Application Information** (Continued)

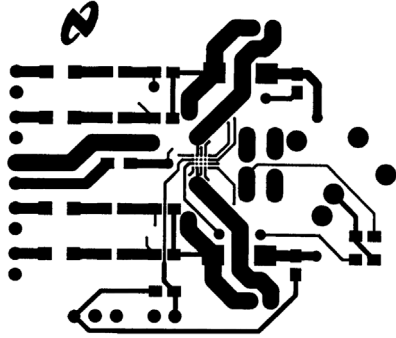

Figure 13. Recommended 20-pin micro SMD PC Board Layout:  
Component-Side Layout

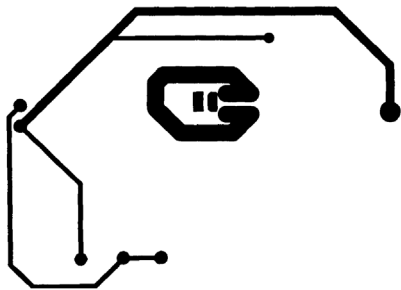

Figure 15. Recommended 20-pin micro SMD PC Board Layout:  
Lower Inner-Layer Layout

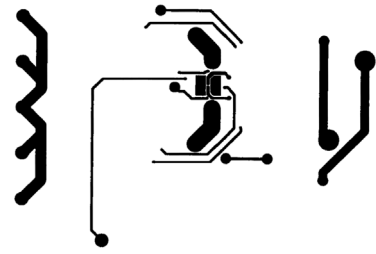

Figure 14. Recommended 20-pin micro SMD PC Board Layout:  
Upper Inner-Layer Layout

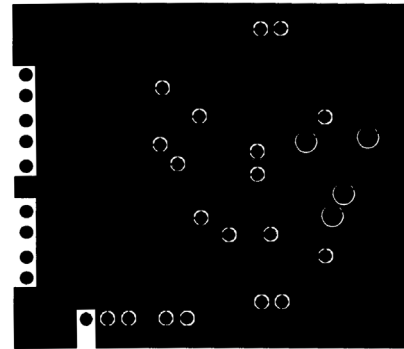
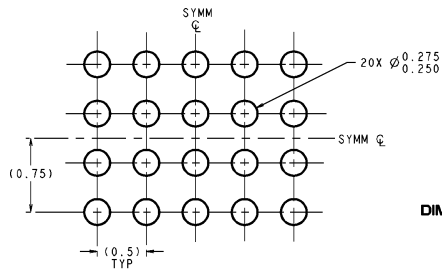

Figure 16. Recommended 20-pin micro SMD PC Board Layout:  
Bottom-Side Layout

**Physical Dimensions** inches (millimeters) unless otherwise noted



DIMENSIONS ARE IN MILLIMETERS

**LAND PATTERN RECOMMENDATION**

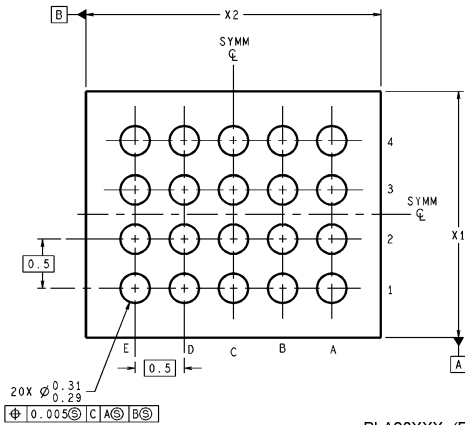
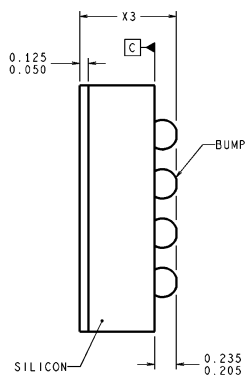
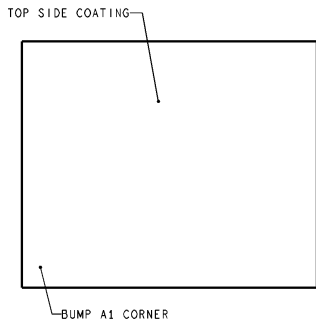

BLA20XXX (Rev B)

**20-Bump micro SMD**  
**Order Number LM4873IBL**  
**NS Package Number BLA20AAB**  
**X1 = 1.996±0.03 X2 = 2.492±0.03 X3 = 0.945±0.10**

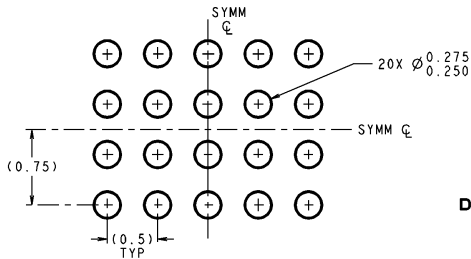

DIMENSIONS ARE IN MILLIMETERS

**LAND PATTERN RECOMMENDATION**

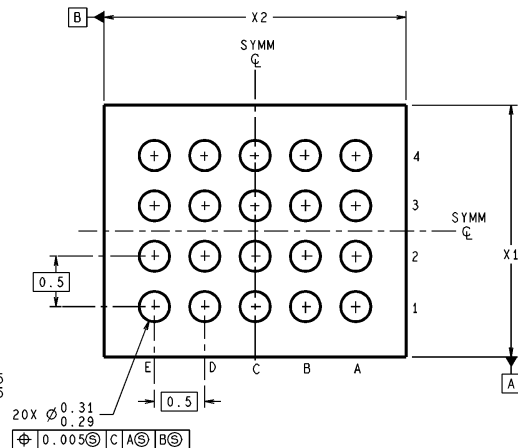
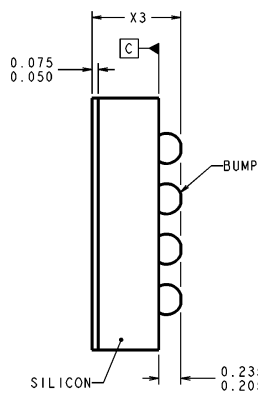
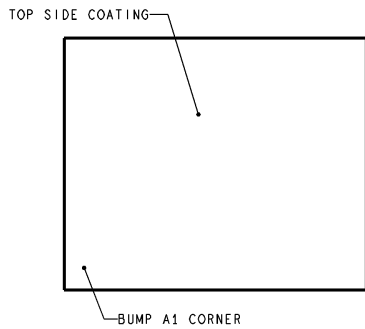

TLA20XXX (Rev A)

**20-Bump micro SMD**  
**Order Number LM4873ITL**  
**NS Package Number TLA20AAA**  
**X1 = 1.996±0.03 X2 = 2.492±0.03 X3 = 0.600±0.075**

**Physical Dimensions** inches (millimeters) unless otherwise noted (Continued)

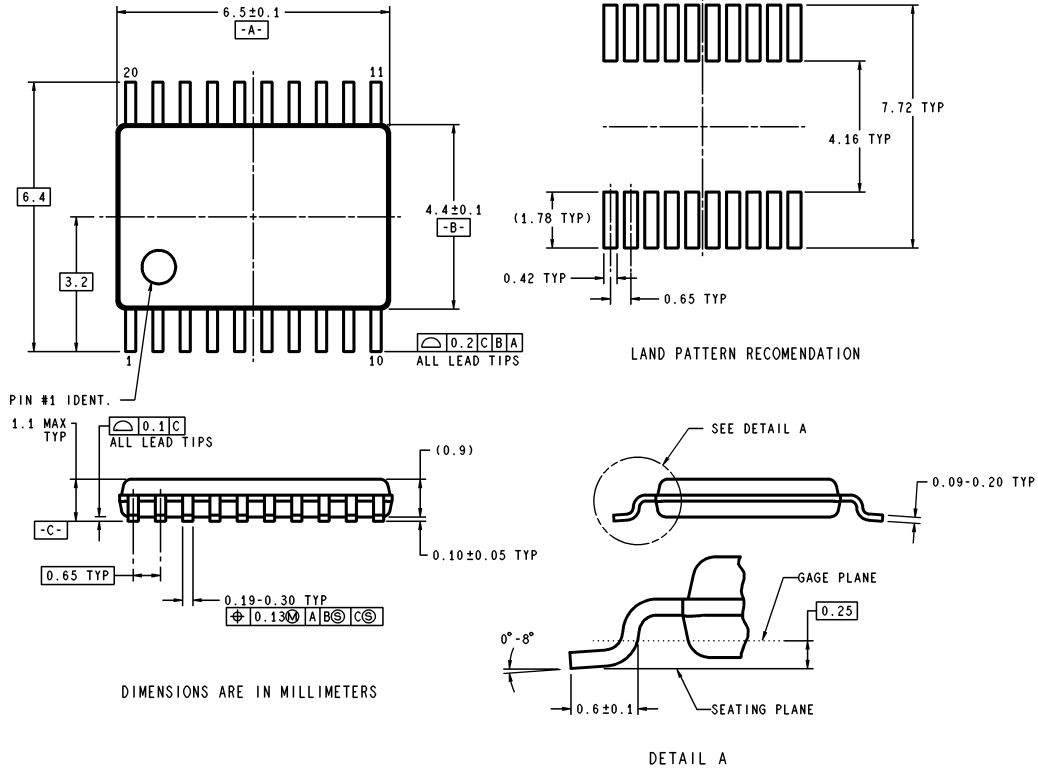

MTC20 (Rev D)

**20-Lead MOLDED PKG, TSSOP, JEDEC, 4.4mm BODY WIDTH**  
**Order Number LM4873MT**  
**NS Package Number MTC20**

**Physical Dimensions** inches (millimeters) unless otherwise noted (Continued)

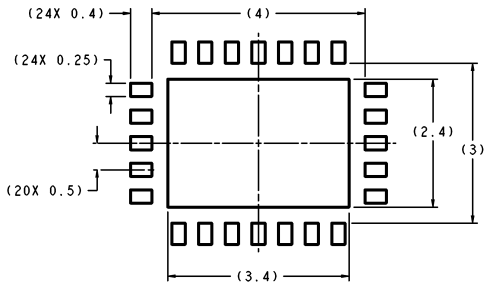

RECOMMENDED LAND PATTERN  
1:1 RATION WITH PKG SOLDER PADS

DIMENSIONS ARE IN MILLIMETERS

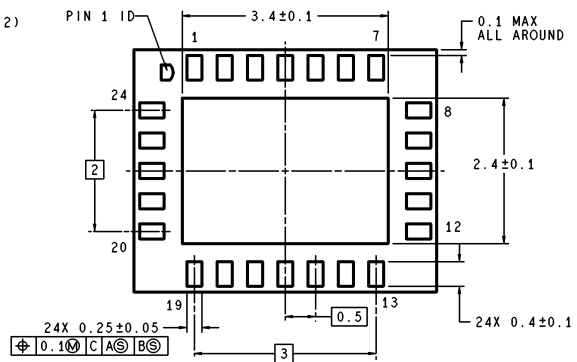
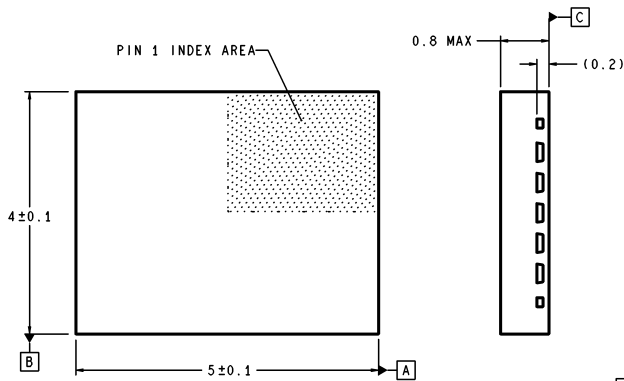

LQA24A (Rev A)

**24-Lead MOLDED PKG, Leadless Leadframe Package LLP**  
**Order Number LM4873LQ**  
**NS Package Number LQA24A**

**Physical Dimensions** inches (millimeters) unless otherwise noted (Continued)

DIMENSIONS ARE IN MILLIMETERS

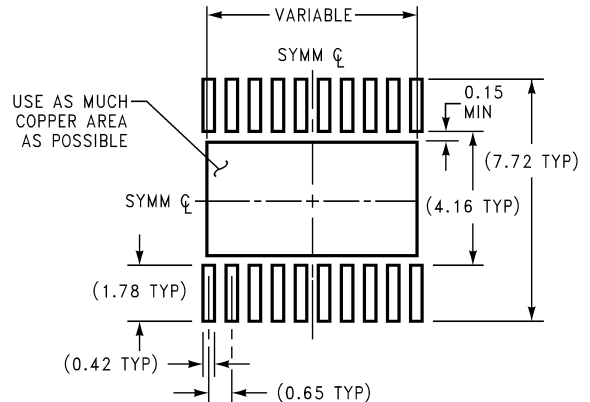
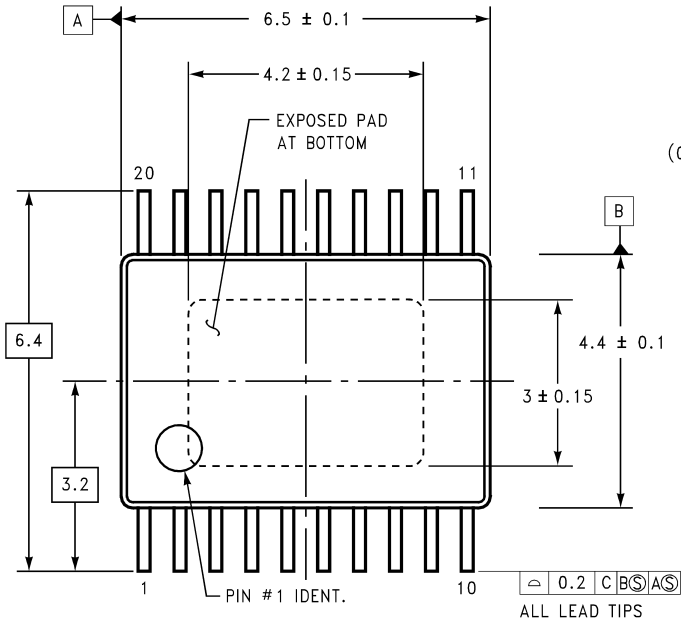

LAND PATTERN RECOMMENDATION

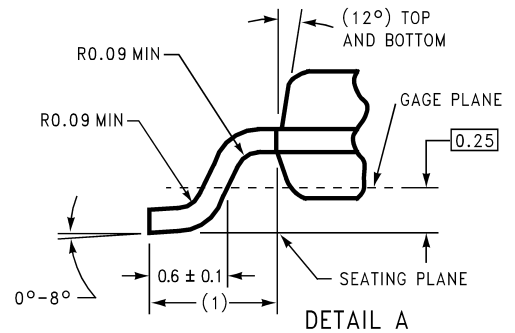

DETAIL A  
TYPICAL, SCALE: 40X

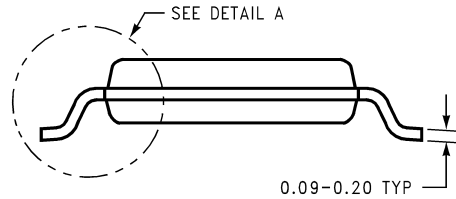
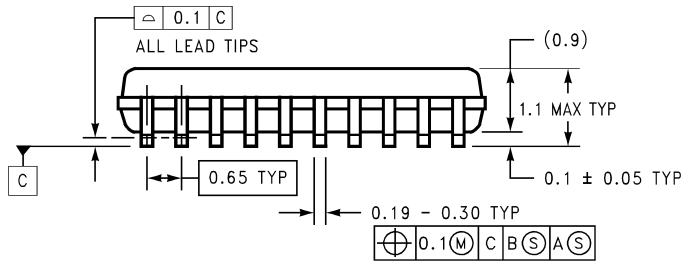

**20-Lead MOLDED TSSOP, EXPOSED PAD, 6.5x4.4x0.9mm**  
**Order Number LM4873MTE**  
**NS Package Number MXA20A**

MXA20A (REV A)



**Physical Dimensions** inches (millimeters) unless otherwise noted (Continued)

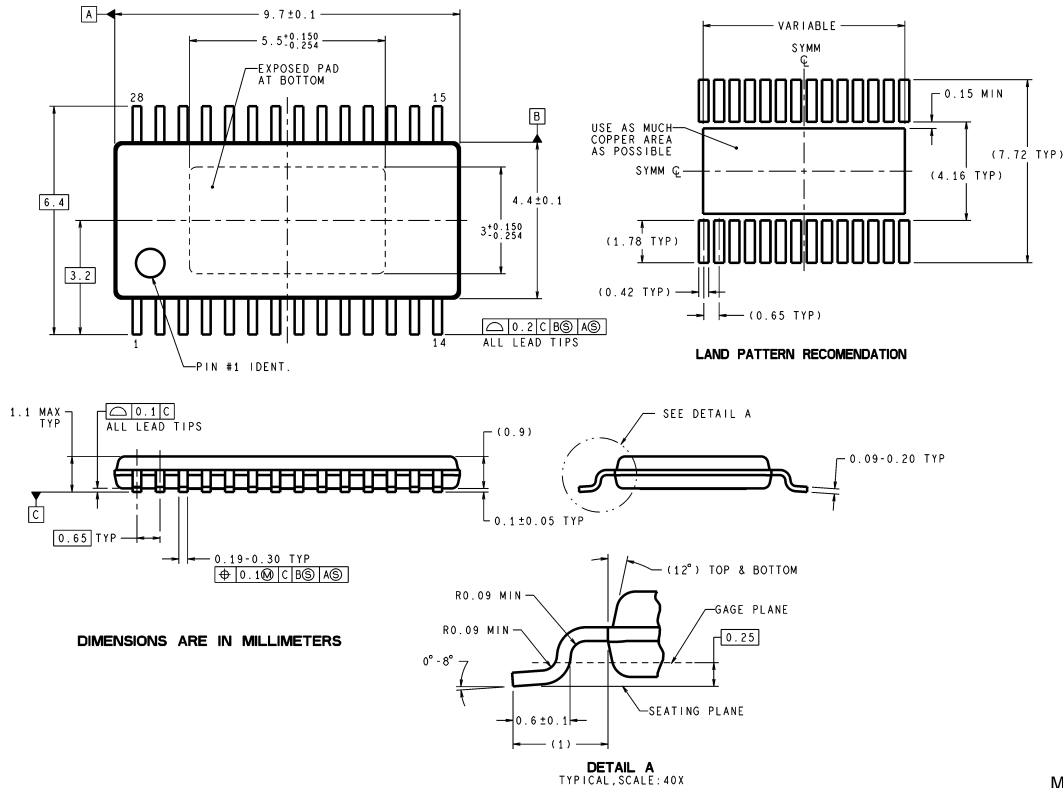

**28-Lead MOLDED TSSOP, EXPOSED PAD, 9.7x4.4x0.9mm**  
**Order Number LM4873MTE-1**  
**NS Package Number MXA28A**

**LIFE SUPPORT POLICY**

NATIONAL'S PRODUCTS ARE NOT AUTHORIZED FOR USE AS CRITICAL COMPONENTS IN LIFE SUPPORT DEVICES OR SYSTEMS WITHOUT THE EXPRESS WRITTEN APPROVAL OF THE PRESIDENT AND GENERAL COUNSEL OF NATIONAL SEMICONDUCTOR CORPORATION. As used herein:

1. Life support devices or systems are devices or systems which, (a) are intended for surgical implant into the body, or (b) support or sustain life, and whose failure to perform when properly used in accordance with instructions for use provided in the labeling, can be reasonably expected to result in a significant injury to the user.
2. A critical component is any component of a life support device or system whose failure to perform can be reasonably expected to cause the failure of the life support device or system, or to affect its safety or effectiveness.

**National Semiconductor Corporation**  
Americas  
Email: support@nsc.com

**National Semiconductor Europe**  
Fax: +49 (0) 180-530 85 86  
Email: europe.support@nsc.com  
Deutsch Tel: +49 (0) 69 9508 6208  
English Tel: +44 (0) 870 24 0 2171  
Français Tel: +33 (0) 1 41 91 8790

**National Semiconductor Asia Pacific Customer Response Group**  
Tel: 65-2544466  
Fax: 65-2504466  
Email: ap.support@nsc.com

**National Semiconductor Japan Ltd.**  
Tel: 81-3-5639-7560  
Fax: 81-3-5639-7507

www.national.com